



INFITAC

Thermal Pistol Sight User Manual

FMP13

1020 West Exchange Parkway, Allen Texas 75013
www.infitacusa.com
support@infitacusa.com





Join Our Community
Discover new tips and tricks from our experienced
pros.
Visit www.infitacusa.com

WARNINGS AND PRECAUTIONS

WARNING! ITAR REQUIREMENTS

These products may be subject to export and foreign trade control laws of the United States and may not be exported without prior approval of the U.S. Department of State.

Learn more at www.infitacusa.com.

WARNING! CHOKING HAZARD

Children under 3 years old can choke or suffocate on small parts of this product. This product is not a toy, keep out of reach of children.

WARNING!

The lens of the product must not be pointed at any sources of intense radiation energy, such as laser-emitting devices or the sun. This may damage the electronic components in the device. Damage caused by failure to comply with this User Manual is not covered under warranty.

IMPORTANT NOTICES!

- Before installing the optic on a firearm, ensure the firearm is UNLOADED.
- If you need to make a product warranty claim, please keep the product packaging and warranty card.

PRECAUTIONS

- The lens is an important optical component. When installing and using it, avoid contamination and damage to the lens surface from oil and various chemicals.
- Do not use chemical solvents or diluents to clean the surface of the device shell. You can use a clean, soft, dry cloth to wipe it.
- Remove the battery when the device is not in use, and store the device in its provided protective case. For long-term storage, keep the device in a dry, well-ventilated environment.
- Do not expose the device to temperatures below -4°F or above +122°F for extended periods.
- If the device malfunctions or is damaged, please send it to our after-sales service department for repair. Unauthorized disassembly, modification, or repair by anyone other than authorized INFITAC personnel is prohibited.

1 OVERVIEW

The FMP13 is an entry-level thermal pistol sight specifically designed for pistols. It can be mounted on the most popular pistols and features a high-sensitivity detection chip that can reproduce infrared image colors and details in both day and night conditions. It also boasts a large 26mm×20mm viewing, touch and button dual operation modes, allowing for quick response in a variety of complex or harsh environments.

2 FEATURES

- High-sensitivity 256×192/12μm detector, NETD≤25mk.
- 1.4 inch touch display with a large 26mm×20mm viewing area.
- Ergonomic design with touch and button dual operation modes.
- Light sensor for automatic display brightness adjustment.
- Multiple image modes and reticle types for quick switching with a finger swipe.
- High reliability, IP67 waterproof, 1200G high shock resistance.

3 TECHNICAL SPECIFICATIONS

| | |
|----------------|---|
| Model | FMP13 |
| Resolution | 256×192/12μm |
| Frame Rate | 50Hz |
| NETD | ≤25mk |
| Objective Lens | 13mm f/1.0 |
| Magnification | 0.5× |
| Digital Zoom | 1×, 2× |
| Field of View | 13.5°×10.1° |
| Focus Range | 2yds-∞ |
| Display | 1.4 inch 360×300 |
| Window Size | 26mm×20mm |
| Color Palettes | White Hot, Black Hot, Red Hot, Rainbow |
| Reticle Types | 3 |
| Reticle Colors | Black, White, Red, Green |

| | |
|---|-----------------------------|
| Battery | 1×CR2 |
| Max. Operating Time (at temp.=71.6°F), | ≥5h* |
| External Power Supply | 5V (USB Type-C) |
| Max. Recoil | 1200g/s ² |
| Operating Temperature | -4°F ~+122°F |
| IP Rating | IP67 |
| Weight (Without Replaceable Battery) | ≤4oz (113g) |
| Dimension | ≤2×1.5×1.7" (50×38×44mm) |

*The actual working time depends on the use intensity of the product;
Improvements may be made to the design and software of this product to enhance its features without prior notice;
You can download this User Manual at our official website: www.infitacusa.com.

4 ACCESSORIES

- FMP13 Thermal Pistol Sight
- RMR Pistol Adapter (compatible with most RMR pistol bases)
- 6-32 UNC ×1/4" Hexalobular Socket Countersunk Screws and Spanner Tool
- Heated Target for Zeroing×2
- Battery: CR2×2
- USB Type-C Cable
- Lens Cloth
- INFITAC Brand Sticker
- INFITAC Hook and Loop Fastener
- User Manual
- Warranty Card

Note:

- The included mounting bracket is a standard RMR interface and is compatible with most RMR pistol bases.
- The included two CR2 batteries are non-rechargeable disposable batteries. Do not attempt to recharge them as it may cause explosions or other hazards.

5 COMPONENTS AND CONTROLS

1. Objective Lens
2. Power Button (Left Button)
3. Menu Button (Right Button)
4. Battery Compartment Waterproof Cover
5. RMR Pistol Adapter
6. Body Mounting Screws
7. Pistol Adapter Screws
8. Light Sensor
9. Screen
10. USB Type-C Port
11. USB Type-C Cover

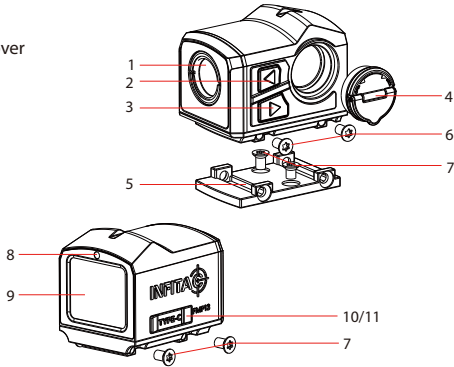

5.1 Models

You can find the product model and SN information on the FMP13 thermal pistol sight body.



You can also enter information menu according to the instructions in Chapter 12 to view the product model and SN information.

6 TECHNICAL INSPECTION

Perform a technical inspection to check the following items each time before you use the device.

- Device Appearance: The shell should be free of visible cracks and damage.
- Objective Lens Condition: The lens surface should be free of cracks, oil, stains, or other sediments.
- Device Installation Status: Securely mounted on the firearm with no signs of loosening.
- Battery Status: The battery is fully charged and there is no foreign matter in the battery compartment.
- The device can be turned on and used normally.
- The device image is clear and free of interference.
- Check that the device's thermal imaging settings are correct.

7 INSTALLATION AND USAGE

To ensure shooting accuracy, first fix the FMP13 device to an appropriate position on the firearm.

- To mount the FMP13 to a pistol, you will need a RMR pistol adapter provided in the package. Follow these steps:
 - a) Locate the mounting holes at the bottom of the RMR pistol adapter ⑤ and align them with the mounting posts on the pistol's RMR mount.
 - b) Use the included mounting screws (6-32 UNC ×1/4" Hexalobular socket screws ⑦) and spanner tool to secure the RMR pistol adapter to the pistol.
 - c) Align the mounting holes at the bottom of the FMP13 with the RMR pistol adapter, and use the included mounting screws (6-32 UNC ×1/4" Hexalobular socket screws ⑥) and spanner tool to secure the FMP13 to the RMR pistol adapter.
- It is recommended to use a torque wrench to tighten the screws of the installation clamps, so as to avoid damaging the support locking mechanism due to being over-tightened, and the recommended torque shall not exceed 20 in/lbs.
- When the sight is used for shooting, please carry out the zeroing operation first according to the instructions as specified in Chapter 12 Zeroing in this User Manual.

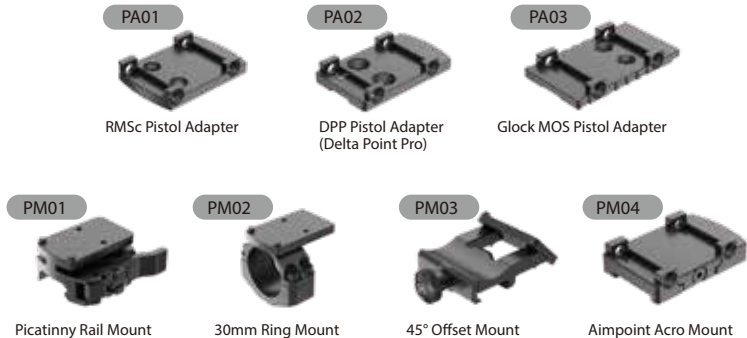

7.1 Optional Accessories

The following image shows some optional FMP13 pistol adapters to fit more types of firearm. For a complete list of available mounting brackets and accessories, visit our website at www.infitacusa.com.



8 BUTTONS AND TOUCH FUNCTIONS

8.1 Button Functions

| Button | Current screen/Menu or Device status | Short press | Long press |
|---|--------------------------------------|--|-----------------------------|
|  Power Button (Left Button) | Device off | / | Power on the device |
| | Home screen | Enter standby mode | Power off the device |
| | In standby mode | Exit standby | / |
| | Main menu/ Parameter interface | Scroll left (circular) | Power off the device |
|  Menu Button (Right Button) | Home screen | Perform manual non-uniformity correction (NUC) | Enter the main menu |
| | Main menu | Enter the next menu | Return to the home screen |
| | Parameter interface | Scroll Right | Return to the previous menu |

8.2 Touch Functions

| Current Screen | Operation | Function |
|----------------|-------------------|-----------------------------|
| Home Screen | Long press | Enter the main menu |
| | Two-finger spread | Digital zoom (0.5x→ 1x) |
| | Two-finger pinch | Digital zoom (1x→0.5x) |
| | Swipe left | Switch reticle type |
| | Swipe right | Switch reticle color |
| | Swipe up/down | Switch color palettes |
| Menu Screen | Short press | Click icon/Confirm |
| | Swipe left/right | Select |
| | Swipe up | Return to the previous menu |

9 BATTERY

The FMP13 thermal pistol sight is powered by one CR2 battery, providing up to 5 hours of normal operation. Before first use, please insert a new or fully charged CR2 battery.

9.1 Battery Installation and Replacement

- Lift the battery cover handle and rotate counterclockwise until the battery cover is removed.
- Insert one CR2 battery into the battery compartment, following the polarity note (positive end inwards).
- Install the battery compartment cover back in the correct direction.
- Rotate the battery cover handle clockwise, lock the battery compartment cover, and fix it to the corresponding position.

9.2 Battery Precautions

- If the device is not in use for a long time, the battery shall be taken out of the device and stored in a dry place.
- The battery compartment is equipped with battery reverse connection protection, but it is best to avoid incorrect installation.
- The device shall be used at the temperature of -4°F ~+104°F, under which the battery is of the best performance.
- When the device is used under sub-zero temperatures, the battery capacity drops. This is normal and does not indicate a defect.

10 EXTERNAL POWER SUPPLY

The FMP13 thermal pistol sight supports external power supply, such as using a phone charger (5V) or a computer USB interface.

Steps for Use:

- Connect the external power source to the FMP13 USB Type-C Port (⑩) using a USB cable.
- If the device is powered on, it will automatically switch to the external power supply and stop using the battery. If the device is powered off, it will automatically power on.
- When the external power is turned off or disconnected, the device will switch to the battery for the power supply.

Precautions:

- When the USB interface is used for the power supply, the default power will come from the power supply, and the internal battery power will be stopped.
- Using a USB interface for power will not charge the battery inside the device.
- Do not leave the device unattended for extended periods when using an external power supply.

11 OPERATING INSTRUCTIONS

WARNING!

The lens of the product must not be pointed at any sources of intense radiation energy, such as laser-emitting devices or the sun. This may damage the electronic components in the device. Damage caused by failure to comply with this User Manual is not covered under warranty.

11.1 Power on

- Refer to Chapter 9 to install the device battery.
- Long press the Power button (②) for 3 seconds. The device will start up, and the INFITAC logo will appear on the display.



11.2 Power off

- Long press the Power button (Ⓜ) for 2 seconds. The power-off countdown screen will appear, counting down from 3.
- Continue long pressing the Power button (Ⓜ). Release the button when the countdown reaches 0. The display will turn black, and the device will power off.



Note:

If you release the Power button (Ⓜ) before the countdown reaches 0, the power-off process will stop, and the device will return to the previous screen.

11.3 Standby Mode

You can manually enter Standby mode to save battery power.

- On the home screen, short press the Power button (Ⓜ). The display will turn black, and the device will enter Standby mode.
- Short press the Power button (Ⓜ) again to exit Standby mode.

After entering Standby mode, you can set how long the device will stay in Standby mode before automatically powering off to save more battery power. For specific functions, refer to Chapter 12 power off settings menu.

11.4 Status Bar Overview



The status bar is located at the top of the image interface and displays the information related to the current operating status of the device. From left to right, there are:

- Digital Zoom: Displays the current image magnification, 0.5x, 1x.
- Shutter Calibration Mode: Displays the current shutter calibration (NUC) mode icon, which can be set to Auto (Ⓜ) or Manual (Ⓜ). In Auto (Ⓜ) mode, a countdown (3, 2, 1, 0) will appear next to NUC in the status bar, and the shutter action will execute when the countdown ends.

- Battery Level: Displays the current battery level, from 0 bars to 5 bars. When external power source is connected, the USB connection icon will appear.

Note:

When the battery icon shows more than 1 bar, it indicates the battery level is above 20% and sufficiently charged. When the battery icon shows 0 bars in white, it indicates low battery. Please replace the battery. When the battery icon shows 0 bars in red, it indicates critically low battery and imminent power off.

11.5 Shutter Calibration

Shutter Calibration (NUC) adjusts the thermal imager's sensor pixel parameters to eliminate image defects caused by pixel shifts. The device will automatically perform a shutter calibration each time it is powered on.

FMP13 offers two shutter calibration modes: Auto and Manual.

Auto

- In Auto mode, the FMP13 executes shutter calibration based on internal software algorithms. When the system determines that shutter calibration is needed, a countdown (3, 2, 1, 0) will appear next to the NUC in the status bar, and the shutter action will be executed when the countdown ends.

- Before the countdown ends, you can short press the Menu button (③) to cancel the shutter calibration.
- In the Auto option, you can still manually execute shutter calibration by short pressing the Menu button (③).

Manual

- On the home screen, short press the Menu button (③) to perform a manual shutter calibration.

11.6 Digital Zoom

The FMP13 pistol sight can digitally magnify images at 1× and 2×.

On the home screen, use finger touch gestures on the display to zoom in or out:

- Spread two fingers to magnify the image from 0.5× to 1×; pinch two fingers to reduce the image from 1× to 0.5×.
- Status bar displays the image magnification during the operation in real time.

| Base Magnification | Digital Zoom Magnification | |
|--------------------|----------------------------|----|
| | 1× | 2× |
| 0.5× | 0.5× | 1× |

11.7 Switch Reticle Type

The FMP13 supports three reticle types. On the home screen, swipe left with one finger to switch between reticle types 1-3.



6MOA dot



6MOA dot & 65MOA circle

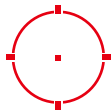

6MOA dot & 130MOA circle

11.8 Switch Reticle Color

The FMP13 supports four reticle colors (Black, White, Red, and Green). On the home screen, swipe right with one finger to switch reticle colors.

11.9 Switch Color Palettes

The FMP13 supports four color palettes (Black Hot, White Hot, Red Hot, and Rainbow). On the home screen, swipe up or down with one finger to switch color palettes modes.

12 MAIN MENU

Button Operations:

- On the home screen, long press the Menu button (③) to enter the menu.
- Short press the Power button (②) to switch menu.
- Short press the Menu button (③) to modify the parameters of the current menu or enter the next-level parameter menu.
- On all menu screens, long press the Menu button (③) to return to the previous menu screen.

Touch Operations:

- On the home screen, long press the screen to enter the menu.
- Swipe left or right to switch menu.
- Click the Menu icon to modify the parameters of the current menu or enter the next-level parameter menu.
- On the parameter setting menu, click the + or - icons to adjust parameter options, or swipe left or right to adjust parameter options.
- On all menu screens, swipe up from the bottom of the screen to return to the previous menu screen.
-

Notes:

- If no operation is performed within 60 seconds on some menus, the device will automatically return to the home screen without saving parameter modification.
- The menu options support a combination of button and touch operations.

Menu Functions and Descriptions

 On the brightness menu, you can adjust the screen brightness.

- There are six brightness levels available: Auto, 1, 2, 3, 4, 5. Auto allows the screen brightness to adjust automatically.
- The default brightness setting is Auto.

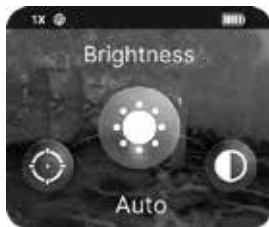

 On the contrast menu, you can adjust the image contrast level:

- There are six contrast levels available: 0, 1, 2, 3, 4, 5.
- The default contrast setting is 3.

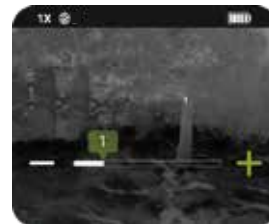



On the calibration menu, you can choose between Auto and Manual:

The default calibration setting is Auto.

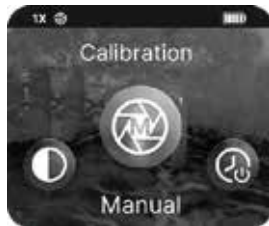

On the zeroing menu, you can adjust the reticle's X/Y position to match the actual point of impact.

The zeroing menu displays the following functions:

- "X": Horizontal movement of the reticle.
- "Y": Vertical movement of the reticle.
- "-": Move one pixel left or down.
- "+": Move one pixel right or up.
- Reticle: Current reticle position.
- Red Cross: Indicates the original reticle position.

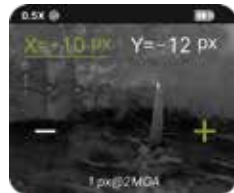



After entering the zeroing menu, X is selected by default (The X icon is green). Short press the Power button (②) or click the X/Y to switch between X and Y options. The selected option turns green, while the unselected option remains white.

- Button Operation: Select the X/Y option, and short press the Menu button (③) to adjust the reticle position in the horizontal/vertical direction. Short press the Power button (②) to move the reticle one pixel left/down, and short press the Menu button (③) to move the reticle one pixel right/up.
- Touch Operation: Click X or Y to select the direction for adjustment. Click "+" or "-" to move the reticle position in the "X" or "Y" direction.

 On the power off settings menu, you can choose to automatically power off the device after 30 minutes, 60 minutes, 90 minutes, 120 minutes, or 180 minutes of standby if the screen is not woken up.

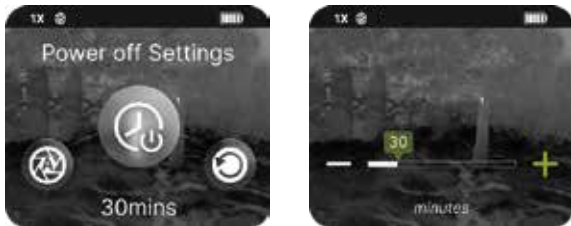
When OFF is selected, the Standby Auto Power-Off function is disabled, and the device will remain in standby until the battery is depleted. The default Power off Settings is OFF.



 On the factory reset menu, you can choose to restore certain functions of the device to their factory default settings.

The following functions will be restored to their default parameters after finishing the reset:

- Screen Brightness: Auto
- Contrast: 3
- Power off Settings: OFF
- Color palettes: White Hot
- Digital Zoom: 1x
- Reticle Color: Red
- Reticle Type: 6MOA dot
- Calibration: Auto
- Zeroing: 0, 0

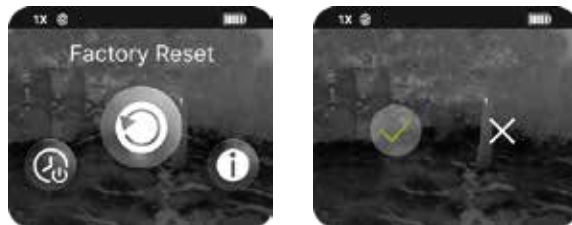



On the system information menu, you can view the relevant information of the current device (device model, PN, SN, software version, hardware version).

13 ZEROING

It is recommended to carry out the zeroing operation within the range of operating temperature of the sight.

- Select a suitable target at the desired distance (e.g., a shooting target 32.8ft away).
- Ensure the firearm is unloaded, not chambered, and safe.
- Following the installation instructions in Chapter 7, use the appropriate pistol adapter to fix the sight to the firearm.
- Start the sight and adjust the relevant settings according to the operating instructions in Chapter 11.
- Select the zeroing setting: Enter the Zeroing menu screen from the home screen using button or touch operations.
- On the zeroing menu screen, the coordinate positions (X-axis, Y-axis) of the reticle are displayed at the top of the screen.
- Ensure firearm safety, load ammunition, aim at the set target, fire a shot, and observe the point of impact position on the screen.

- If the point of impact does not match the reticle position, keep the aiming position unchanged and maintain the aiming posture. Follow the zeroing setting operation method in Chapter 12 to move the reticle X/Y position until it overlaps with the point of impact. long press the Menu button (Ⓜ) or swipe up from the bottom of the screen to save the current reticle position and return to the previous menu.
- Ensure firearm safety, load ammunition, aim at the set target, fire another shot, and observe whether the point of impact matches the reticle position.
- If it still does not match, repeat the above steps until the point of impact matches the reticle position.

14 CLEANING & GENERAL CARE

The maintenance should be carried out at least twice a year and includes the following steps:

- Use a clean, soft, dry cotton cloth to wipe the external surfaces of the product's metal and plastic parts, removing dust and dirt.
- Clean the electric contact and battery slots on the device using a non-greasy organic solvent.
- Check the glass surface of the eyepiece and lens. If necessary, clear off the dust and sand on the lens (it is perfect to use a non-contact method). Use a specialized wiping tool and solvent to clean the optical surfaces.

15 GENERAL TROUBLESHOOTING

The following table lists some potential issues when operating the device and their corresponding solutions. If you encounter these issues while using the product, please follow the suggestions and solutions in the table to troubleshoot and fix them. If the issue persists or an unlisted fault occurs that cannot be self-repaired, contact the supplier for factory repair immediately. You can also visit www.infitacusa.com for solutions to your product problems, or email us at support@infitacusa.com for more detailed information. Do not disassemble and repair it yourself or have it repaired by a third party not authorized by INFITAC, as this will void your product warranty.

| Fault | Possible Causes | Solutions |
|---|--|--|
| The sight cannot be started. | The battery is out of charge. | Replace with a new battery. |
| | Battery is inserted incorrectly. | Insert the battery correctly. |
| The device cannot be powered by using an external power supply. | The USB cable is damaged. | Replace the USB cable. |
| | The external power supply is insufficient. | If necessary, check the external power supply. |
| Images are unclear or the background is not even. | Calibration is required. | Perform image calibration as per Chapter 11.5. |
| The image is too dark. | The screen is not bright enough. | Adjust the screen brightness. |
| Reticle position shifts after shooting. | The sight is loose. | Check whether the sight is mounted firmly. |
| The icons are clear but the image is blurry. | The lens surface is dusted or iced. | Check the objective lens surface and wipe off dust or frost with a soft cloth. In cold weather, a special antifogging coating can be applied. |

16 WARRANTY POLICY

Under normal use and maintenance conditions, if this product experiences performance failure due to material, workmanship, or manufacturing issues within the warranty period, we promise to provide warranty service.

Our warranty follows the product. During the announced warranty period, at our sole discretion, INFITAC will repair or replace products found defective under normal use without charge, excluding any delivery costs, which will be born by purchaser. We will not be liable for incidental, consequential, or special damages arising out of or in any connection with the use or performance of this product. Our warranty covers only normal use and does not include normal wear and tear of the device's appearance, theft, loss, intentional damage, any force majeure, or any situation arising from unexpected use. Visit www.infitacusa.com/pages/warranty-policy for the latest complete warranty information and other conditions.

17 TRADEMARKS

 is trademark owned by INFITAC. For more details, visit www.infitacusa.com.